

# MASTER VIEW 2/4 PORT PS/2 KVM SWITCH

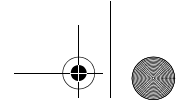

## USER MANUAL **CS-72E** **CS-74E**



## **FCC Information**

---

This is an FCC Class A product. In a domestic environment this product may cause radio interference in which case the user may be required to take adequate measures.

This equipment has been tested and found to comply with the limits for a Class A digital device, pursuant to Part 15 of the FCC Rules. These limits are designed to provide reasonable protection against harmful interference when the equipment is operated in a commercial environment. This equipment generates, uses and can radiate radio frequency energy and, if not installed and used in accordance with the instruction manual, may cause harmful interference to radio communications. Operation of this equipment in a residential area is likely to cause harmful interference in which case the user will be required to correct the interference at his own expense.

## **RoHS**

---

This product is RoHS compliant.

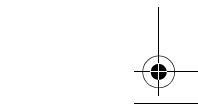
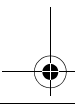
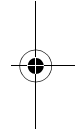
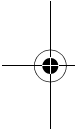

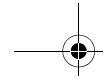

---

## User Notice

---

All information, documentation, and specifications contained in this manual are subject to change without prior notification by the manufacturer. The manufacturer makes no representations or warranties, either expressed or implied, with respect to the contents hereof and specifically disclaims any warranties as to merchantability or fitness for any particular purpose. Any of the manufacturer's software described in this manual is sold or licensed `as is'. Should the programs prove defective following their purchase, the buyer (and not the manufacturer, its distributor, or its dealer), assumes the entire cost of all necessary servicing, repair and any incidental or consequential damages resulting from any defect in the software.

The manufacturer of this system is not responsible for any radio and/or TV interference caused by unauthorized modifications to this device. It is the responsibility of the user to correct such interference.

The manufacturer is not responsible for any damage incurred in the operation of this system if the correct operational voltage setting was not selected prior to operation. **PLEASE VERIFY THAT THE VOLTAGE SETTING IS CORRECT BEFORE USE.**

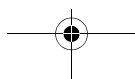
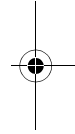
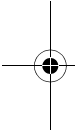

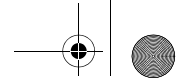

## **Safety Instructions**

---

- ◆ Read all of these instructions. Save them for future reference.
- ◆ Follow all warnings and instructions marked on the device.
- ◆ Do not place the device on any unstable surface (cart, stand, table, etc.). If the device falls, serious damage will result.
- ◆ Do not use the device near water.
- ◆ Do not place the device near, or over, radiators or heat registers.
- ◆ The device cabinet is provided with slots and openings to allow for adequate ventilation. To ensure reliable operation, and to protect against overheating, these openings must never be blocked or covered.
- ◆ The device should never be placed on a soft surface (bed, sofa, rug, etc.) as this will block its ventilation openings. Likewise, the device should not be placed in a built in enclosure unless adequate ventilation has been provided.
- ◆ Never spill liquid of any kind on the device.
- ◆ Unplug the device from the wall outlet before cleaning. Do not use liquid or aerosol cleaners. Use a damp cloth for cleaning.
- ◆ The device should be operated from the type of power source indicated on the marking label. If you are not sure of the type of power available, consult your dealer or local power company.
- ◆ Do not allow anything to rest on the power cord or cables. Route the power cord and cables so that they cannot be stepped on or tripped over.
- ◆ If an extension cord is used with this device make sure that the total of the ampere ratings of all products used on this cord does not exceed the extension cord ampere rating. Make sure that the total of all products plugged into the wall outlet does not exceed 15 amperes.
- ◆ To help protect your system from sudden, transient increases and decreases in electrical power, use a surge suppressor, line conditioner, or uninterruptible power supply (UPS).
- ◆ Position system cables and power cables carefully; Be sure that nothing rests on any cables.
- ◆ When connecting or disconnecting power to hot pluggable power supplies, observe the following guidelines:
- ◆ If the system has multiple sources of power, disconnect power from the system by unplugging all power cables from the power supplies.

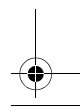
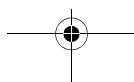
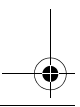
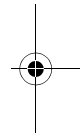
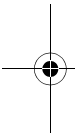

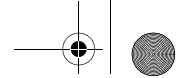

- ◆ Never push objects of any kind into or through cabinet slots. They may touch dangerous voltage points or short out parts resulting in a risk of fire or electrical shock.
- ◆ Do not attempt to service the device yourself. Refer all servicing to qualified service personnel.
- ◆ If the following conditions occur, unplug the device from the wall outlet and bring it to qualified service personnel for repair.
  - ◆ The power cord or plug has become damaged or frayed.
  - ◆ Liquid has been spilled into the device.
  - ◆ The device has been exposed to rain or water.
  - ◆ The device has been dropped, or the cabinet has been damaged.
  - ◆ The device exhibits a distinct change in performance, indicating a need for service.
  - ◆ The device does not operate normally when the operating instructions are followed.
- ◆ Only adjust those controls that are covered in the operating instructions. Improper adjustment of other controls may result in damage that will require extensive work by a qualified technician to repair.

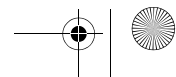
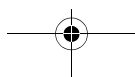
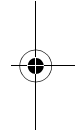
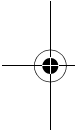



## **Package Contents**

---

The CS-72E / CS-74E package consists of:

- 1 CS-72E or CS-74E PS/2 KVM Switch
- 1 Console Connector Cable
- 2 Custom KVM Cables (CS-72E), or
- 4 Custom KVM Cables (CS-74E)
- 1 User Manual\*
- 1 Quick Start Guide

Check to make sure that all of the components are present and in good order. If anything is missing, or was damaged in shipping, contact your dealer.

Read this manual thoroughly and follow the installation and operation procedures carefully to prevent any damage to the switch or to any other devices on the installation.

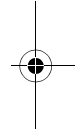
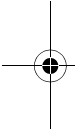

---

\* Features may have been added to the product since this manual was printed. Please visit our website to download the most up to date version of the manual.

---

© Copyright 2006-2011 ATEN® International Co., Ltd.  
Manual Part No. PAPE-0259-100G  
Printing Date: 2011-06-24

ATEN and the ATEN logo are registered trademarks of ATEN International Co., Ltd. All rights reserved. All other brand names and trademarks are the registered property of their respective owners.

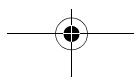
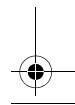
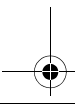



## Contents

FCC Information . . . . .	ii
RoHS . . . . .	ii
User Notice . . . . .	iii
Safety Instructions . . . . .	iv
Package Contents . . . . .	vi
About this Manual . . . . .	ix
Conventions . . . . .	x
Getting Help . . . . .	x
<b>1. Introduction</b>	
Overview . . . . .	1
Features . . . . .	2
Requirements . . . . .	3
Console . . . . .	3
Computers . . . . .	3
Cables . . . . .	3
<b>2. Hardware Setup</b>	
CS-72E Front View . . . . .	5
CS-72E Rear View . . . . .	6
CS-74E Front View . . . . .	7
CS-74E Rear View . . . . .	8
Installation . . . . .	9
<b>3. Operation</b>	
Manual Port Selection . . . . .	11
Hotkey Port Selection . . . . .	12
Port Selection . . . . .	12
Auto Scan Mode . . . . .	13
<b>Appendix</b>	
CS-74E Hotkey Summary Table . . . . .	15
Specifications . . . . .	16
Troubleshooting . . . . .	17
LED Display . . . . .	18
Limited Warranty . . . . .	18

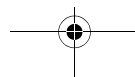



This Page Intentionally Left Blank

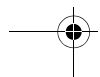
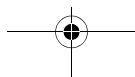
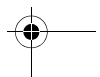
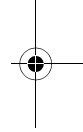
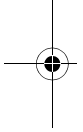





---

## About this Manual

---

This User Manual is provided to help you get the most from your *c/c* system. It covers all aspects of installation, configuration and operation. An overview of the information found in the manual is provided below.

**Chapter 1, Introduction**, introduces you to the CS-72E / CS-74E. Its purpose, features and benefits are described.

**Chapter 2, Hardware Setup**, presents the front and back panel components, and explains how to connect the switch to your computers.

**Chapter 3, Operation**, describes the various port switching procedures.

**An Appendix**, provides specifications and other technical information regarding the CS-72E / CS-74E

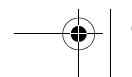
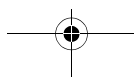
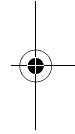
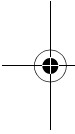



## Conventions

---

This manual uses the following conventions:

- Monospaced    Indicates text that you should key in.
- [ ]                Indicates keys you should press. For example, [Enter] means to press the **Enter** key. If keys need to be chorded, they appear together in the same bracket with a plus sign between them: [Ctrl+Alt].
- 1.                 Numbered lists represent procedures with sequential steps.
- ◆                 Bullet lists provide information, but do not involve sequential steps.
- Indicates selecting the option (on a menu or dialog box, for example), that comes next. For example, Start → Run means to open the *Start* menu, and then select *Run*.
-                 Indicates critical information.

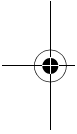

## Getting Help

---

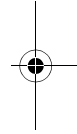

If you need to contact ATEN technical support with a problem, visit our website at [www.aten.com](http://www.aten.com).

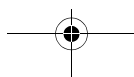



# Chapter 1. Introduction

## Overview

---

The CS-72E / CS-74E KVM (Keyboard, Video, Mouse), switch is a control unit that allows access to two (CS-72E) or four (CS-74E) computers from a single console (keyboard, monitor, and mouse).

With its custom designed connectors, the CS-72E / CS-74E significantly reduces the number of ports required for a 2 or 4 port KVM switch. The design features a custom SPHD-15 male connector for the keyboard, video, and mouse, and SPHD-15 female connectors for the cables that connect the switch to the computers.

The SPHD connectors provide several advantages over standard KVM switch implementations: 1) increased reliability; 2) a handsome, space-saving, modern appearance; and 3) neater, more efficient, cabling that eliminates the usual tangled cable mess. Combined with the modern looking, compact, dual function case that allows the unit to either stand upright or lay flat, the switch can easily be placed in almost any convenient, unobtrusive location.

Setup is fast and easy; plugging cables into their appropriate ports is all that is entailed. There is no software to configure; no need to get involved in complex installation routines; and no need to be concerned with incompatibility problems. Since the CS-72E / CS-74E intercepts keyboard and mouse input directly, it works on any hardware platform and with most operating systems.

The CS-72E / CS-74E provides two convenient methods to bring the KVM focus to the target computer: 1) by pressing one of the port selection switches located on the unit's front panel; and 2) by entering hotkey combinations from the keyboard.

There is no better way to access your multiple computer installation than with a CS-72E / CS-74E KVM switch. By allowing a single console to manage all of the computers, the CS-72E / CS-74E eliminates the expense of purchasing a separate keyboard, monitor, and mouse for each one. Additionally, it saves the extra space and energy costs that additional consoles would require, and it eliminates the inconvenience and wasted effort involved in constantly having to move around from one computer to another.

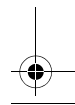
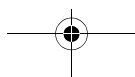
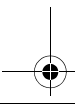
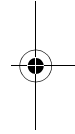
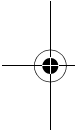

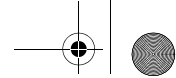

## Features

---

- ◆ Compact, modern, dual function, case – stands upright or lays flat for convenient placement
- ◆ Custom SPHD-15 connectors and custom KVM cables requires only 3 (CS-72E) or 5 ports (CS-74E) for a neat and tidy cable layout
- ◆ Easy to install – no software required – connecting cables to the computers is all it takes
- ◆ Easy to operate – computer selection via port selection switches or hotkeys
- ◆ Power on detection – automatically switches to the first powered on port
- ◆ Auto scan function to monitor computer operation
- ◆ LED display for easy status monitoring
- ◆ Hot pluggable – add or remove computers without powering down the switch
- ◆ Caps Lock, Num Lock, and Scroll Lock states are saved and restored when switching
- ◆ Keyboard and mouse emulation for error free computer booting
- ◆ Supports Microsoft IntelliMouse and the scrolling wheel on most mice
- ◆ Superior video quality – up to 2048 x 1536@60MHz; DDC; DDC2; DDC2B
- ◆ Non-powered
- ◆ Saves Time, Space, Power, and Equipment Costs
- ◆ Supports Windows, Linux, FreeBSD

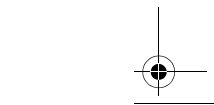
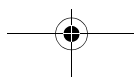
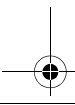
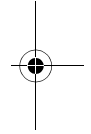
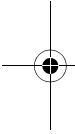

## Requirements

### Console

- ◆ A VGA, SVGA, or Multisync monitor capable of the highest resolution that you will be using on any computer in the installation
- ◆ A PS/2 style keyboard
- ◆ A PS/2 style mouse

### Computers

The following equipment must be installed on each computer that is to be connected to the system:

A VGA, SVGA or Multisync port.

A PS/2 Style keyboard port.

A PS/2 Style mouse port.

### Cables

Only cable sets specifically designed to work with this switch may be used.

- ◆ The CS-72E package provides one *Console Connector Cable* and two 1.2m KVM cable sets.
- ◆ The CS-74E package provides one *Console Connector Cable*; two 1.2m KVM cable sets; and two 1.8m KVM cable sets.

KVM cable sets are also available in 3 and 6 meter lengths. If you need additional cable sets, contact your dealer – refer to the table below for length and part number:

Length (m)	Part Number
1.2	2L5201P-2
1.8	2L5202P-2
3.0	2L5203P-2
6.0	2L5206P-2



This Page Intentionally Left Blank

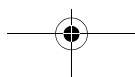
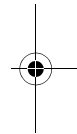
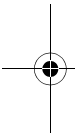

## Chapter 2. Hardware Setup

### CS-72E Front View

---

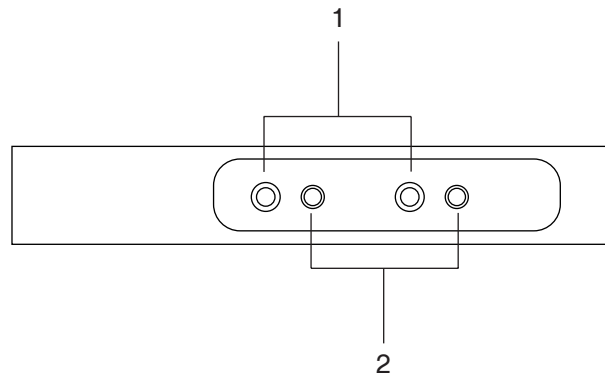

#### 1. Port Selection Switches

- ◆ Press a switch to give the KVM focus to the computer attached to its corresponding port.
- ◆ Pressing Buttons 1 and 2 simultaneously for more than 3 seconds starts Auto Scan Mode (see p. 13).
- ◆ While in Auto Scan Mode, pressing any button exits Auto Scan Mode and switches the KVM focus to its corresponding port.

#### 2. Port LEDs

The Port LEDs are built into the Port Selection Switches. A lit LED indicates that its corresponding Port is the one that has the KVM focus. Depending on the Port's status, the LED may flash according to a specific pattern (see p. 18 for details).

## CS-72E Rear View

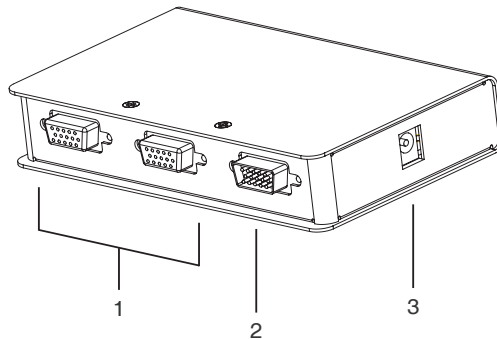

### 1. KVM Ports\*

The KVM cables that connect the unit to the keyboard, video, and mouse ports on the computers you are installing can plug into any available port.

### 2. Console Port\*

The Console Adapter Cable plugs in here.

### 3. Power Jack

The power adapter cable plugs in here.

---

**Note:** The CS-72E does not require external power. Use of a power adapter is optional, and requires a separate purchase. (See the note under the *Installation* section on page 9).

---

---

\* The shape of the KVM and Console port connectors has been specifically modified so that only cables designed to work with this switch can plug in (see *Cables*, page 3, for details).

---



## CS-74E Front View

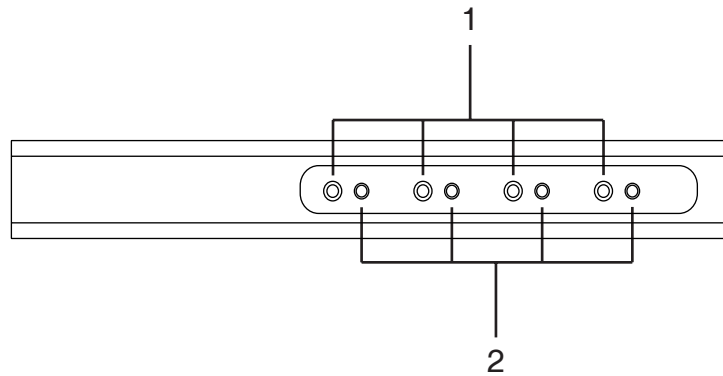

### 1. Port Selection Switches

- ◆ Press a switch to give the KVM focus to the computer attached to its corresponding port.
- ◆ Pressing Buttons 1 and 2 simultaneously for more than 3 seconds starts Auto Scan Mode (see p. 13).
- ◆ While in Auto Scan Mode, pressing any button exits Auto Scan Mode and switches the KVM focus to its corresponding port.

### 2. Port LEDs

The Port LEDs are built into the Port Selection Switches. A lit LED indicates that its corresponding Port is the one that has the KVM focus. Depending on the Port's status, the LED may flash according to a specific pattern (see p. 18 for details).

## CS-74E Rear View

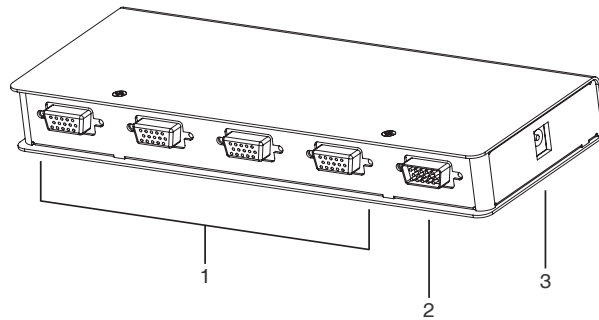

### 1. KVM Ports\*

The KVM cables that connect the unit to the keyboard, video, and mouse ports on the computers you are installing can plug into any available port.

### 2. Console Port\*

The Console Adapter Cable plugs in here.

### 3. Power Jack

The power adapter cable plugs in here.

---

**Note:** The CS-74E does not require external power. Use of a power adapter is optional, and requires a separate purchase. (See the note under the *Installation* section on page 9).

---

---

\* The shape of the KVM and Console port connectors has been specifically modified so that only cables designed to work with this switch can plug in (see *Cables*, page 3 for details).

---

## Installation



1. Important safety information regarding the placement of this device is provided on page iv. Please review it before proceeding.
2. Make sure that power to all the devices you will be connecting up have been turned off. You must unplug the power cords of any computers that have the Keyboard Power On function.

Refer to the installation diagrams on the next page (the numbers in the diagrams correspond to the steps indicated below) as you do the following:

1. Plug the Console Adapter Cable into the Console Port Connector on the rear panel of the switch.
2. Plug your keyboard, monitor and mouse into their respective connectors on the Console Adapter Cable. The connectors are color coded and marked with an appropriate icon for easy identification.
3. Use the custom KVM cable sets (described in the *Cables* section, page 3), to connect the CS-74E KVM Ports to the monitor, keyboard and mouse ports of the computers you are installing.
4. If you choose to use external power, plug the power adapter into an AC power source, then plug the power adapter cable into the unit's Power Jack.

**Note:** Under ordinary circumstances the switch doesn't require external power. If, for some reason, you find that the quality deteriorates (when using long cables, for example), you may want to add a power adapter. The power adapter should be DC9V; 300mA, with the inside positive and the outside negative: 

5. Turn on the power to the computers.

**Note:** The CS-74E's default is to link to the first computer you turn on.

CS-72E / CS-74E User Manual

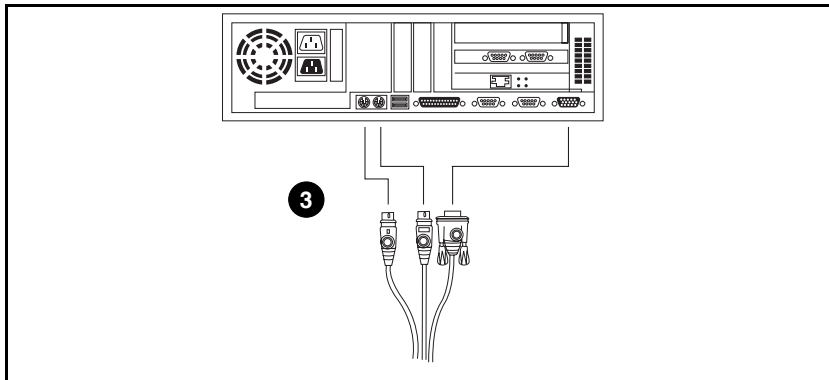
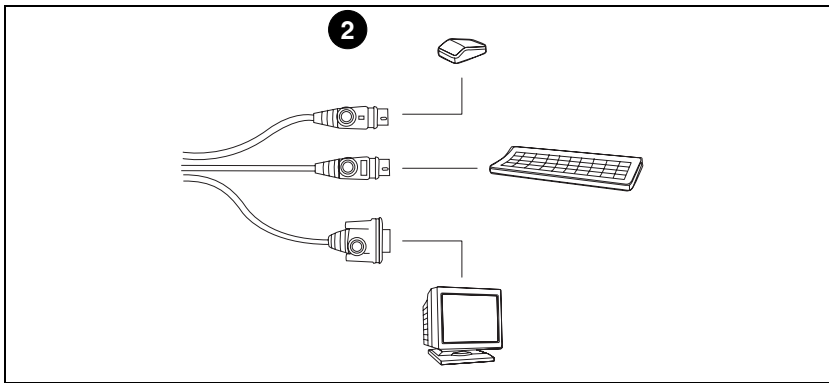
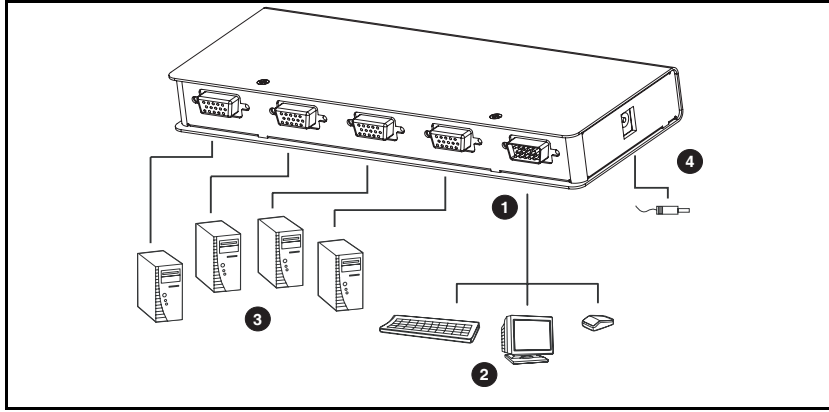



## Chapter 3. Operation

### Manual Port Selection

---

- ◆ With manual port selection you simply press the appropriate port selection switch on the unit's front panel to give the KVM focus to its corresponding port. The port's Port LED lights to indicate that it has the KVM focus.
- ◆ Pressing and holding buttons 1 and 2 for more than 3 seconds invokes *Auto Scan Mode*. Auto Scan Mode allows you to automatically cycle through the ports at regular 5 seconds intervals so that you can monitor the computer activity without having to constantly switch ports yourself.
- ◆ When a port is being accessed under Auto Scan Mode, its corresponding Port LED flashes.
- ◆ While Auto Scan Mode is in effect, ordinary keyboard and mouse functions are suspended. You must exit Auto Scan Mode in order to regain normal control of their use.
- ◆ To exit Auto Scan Mode, press any port selection switch. The KVM focus goes to the port that corresponds to the switch you pressed.

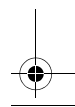
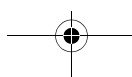
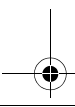
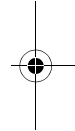
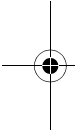

## Hotkey Port Selection

Hotkey port selection allows you to directly access a computer from the keyboard, instead of having to manually switch to it with the port selection switches. For both the CS-72E and CS-74E, hotkey operations begin by tapping the *Scroll Lock* key twice.

### Port Selection

- ◆ For the two port CS-72E, tapping [Scroll Lock] [Scroll Lock] toggles the KVM focus between the two ports.
- ◆ For the four port CS-74E, hotkey port switching is explained in the table below:

Hotkey	Action
[Scroll Lock] [Scroll Lock] [↓]	Brings the KVM focus from the port that currently has the focus to the next port on the installation: 1 to 2; 2 to 3; 3 to 4; 4 to 1.
[Scroll Lock] [Scroll Lock] [↑]	Brings the KVM focus from the port that currently has the focus to the previous port on the installation: 4 to 3; 3 to 2; 2 to 1; 1 to 4.
[Scroll Lock] [Scroll Lock] [Fn]	Where <b>Fn</b> represents a function key (from [F1] to [F4]) that corresponds to the CS-74E's KVM port (1 to 4). When you enter the combination the KVM focus goes directly to the port that corresponds to the function key. For example, if you were to enter the following combination:  <b>[Scroll Lock] [Scroll Lock] [F4]</b>  The KVM focus would go to the computer connected to port 4.

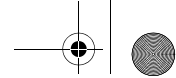

### **Auto Scan Mode**

In addition to manually invoking Auto Scan Mode (discussed on page 11), the CS-74E also provides hotkey invocation.

- ◆ To invoke Auto Scan Mode using hotkeys instead of manually, enter the following combination:

[Scroll Lock] [Scroll Lock] [A][Enter]

- ◆ While Auto Scan Mode is in effect, ordinary keyboard and mouse functions are suspended. You must exit Auto Scan Mode in order to regain normal control of their use.
- ◆ To exit Auto Scan Mode, press **[Esc]** or **[Spacebar]**. The KVM focus stays with the last port that was accessed under Auto Scan Mode.

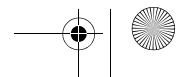
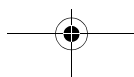
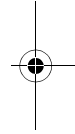
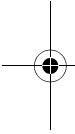



This Page Intentionally Left Blank

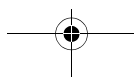
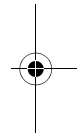
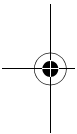



## Appendix

### CS-74E Hotkey Summary Table

The CS-74E hotkey functions are summarized in the following table:

Hotkey	Action
[Scroll Lock] [Scroll Lock] [↓]	Brings the KVM focus from the port that currently has the focus to the next port on the installation: 1 to 2; 2 to 3; 3 to 4; 4 to 1.
[Scroll Lock] [Scroll Lock] [↑]	Brings the KVM focus from the port that currently has the focus to the previous port on the installation: 4 to 3; 3 to 2; 2 to 1; 1 to 4.
[Scroll Lock] [Scroll Lock] [Fn]	Where <b>Fn</b> represents a function key (from [F1] to [F4]) that corresponds to the CS-74E's KVM port (1 to 4). When you enter the combination the KVM focus goes directly to the port that corresponds to the function key. For example, if you were to enter the following combination:  <b>[Scroll Lock] [Scroll Lock] [F4]</b>  The KVM focus would go to the computer connected to port 4.
[Scroll Lock] [Scroll Lock] [A] [Enter]	Invokes Auto Scan Mode.
[Esc] or [Spacebar]	Exits Auto Scan Mode.

## CS-72E / CS-74E User Manual

## Specifications

Function		CS-72E	CS-74E
KVM Ports		2	4
Port Selection		Pushbutton; Hotkey	
Connectors	KVM	2 x SPHD-15 F (Yellow)	4 x SPHD-15 F (Yellow)
	Console	1 x SPHD-15 M (Yellow)	
LEDs		2 x Selected Port (Green)	4 x Selected Port (Green)
Power Consumption		DC9V, 0.9W	DC9V, 1.35W
Power Adapter		DC9V; 300mA	
Emulation	Keyboard	PS/2	
	Mouse	PS/2	
Video		2048 x 1536 @ 60MHz	
Scan Interval		5 Seconds	
Environment		Operating Temperature: 0 ~ 50° C Storage Temperature: -20 ~ 60° C Humidity: 0 ~ 80% RH – Noncondensing	
Housing		Metal	
Weight (kg)		0.32 kg	0.49 kg
Dimensions (L x W x H cm)		12.50 x 8.00 x 2.50	20.00 x 8.00 x 2.50

## Troubleshooting

Symptom	Cause	Action
Keyboard <sup>1</sup> and/or Mouse <sup>2</sup> Not Responding	Loose cables.	Check all cable connections to make sure they are completely seated in their sockets.
	Switch is in Auto Scan Mode.	1. Press a port selection switch to manually exit Auto Scan Mode. 2. Press [Esc] or [Spacebar] to hotkey exit Auto Scan Mode. (CS-74E only)
	Keyboard / Mouse needs to be reset.	Unplug the keyboard / mouse from the Console Keyboard Port, then plug it back in.
	Mouse set to serial mode.	Some mice can be set to act as a PS/2 or a serial mouse. Make sure the mouse is set to PS/2 mode.
	Incorrect mouse driver.	Check your Device Manager to be sure that the correct driver for your mouse (obtained from the manufacturer, or supplied by the operating system), has been installed. Because of the wide variety of mouse driver standards for the modern series of mice (the ones with the extra buttons and wheels), this unit only supports all of the extra features of the Microsoft Intellimouse. It supports the scroll wheel function of most other mice.
	Switch needs to be reset.	Turn off the computers; wait 5 seconds; turn the computers back on.
Video Problems	Loose cables.	Check all cable connections to make sure they are completely seated in their sockets.
	Resolution and/or bandwidth set too high.	This unit supports VGA, SVGA, Multisync, and XGA (interlaced), with resolutions of up to 2048x1536.

1. This unit is designed to work with PS/2 keyboards and mice. XT (84 key) and AT keyboards will not work. Serial mice will not work.
2. Some Notebooks, notably the IBM Thinkpad and Toshiba Tecra, have trouble when their mouse and keyboard ports are used simultaneously. To avoid this, only connect the mouse port or the keyboard port. If you connect the mouse port, you will need to use the notebook's keyboard when the notebook becomes the active computer.

## LED Display

---

The information provided by the front panel LED activity is explained in the following table:

Activity	Explanation
Off	Port is not selected.
On – Steady	The computer connected to the LED's corresponding port is the one that has the KVM focus.
On – Flashing	The computer connected to the LED's corresponding port is the one that has the KVM focus and is being accessed in Auto Scan mode.

## Limited Warranty

---

IN NO EVENT SHALL THE DIRECT VENDOR'S LIABILITY EXCEED THE PRICE PAID FOR THE PRODUCT FROM DIRECT, INDIRECT, SPECIAL, INCIDENTAL, OR CONSEQUENTIAL DAMAGES RESULTING FROM THE USE OF THE PRODUCT, DISK, OR ITS DOCUMENTATION.

The direct vendor makes no warranty or representation, expressed, implied, or statutory with respect to the contents or use of this documentation, and especially disclaims its quality, performance, merchantability, or fitness for any particular purpose.

The direct vendor also reserves the right to revise or update the device or documentation without obligation to notify any individual or entity of such revisions, or update. For further inquiries, please contact your direct vendor.