

4

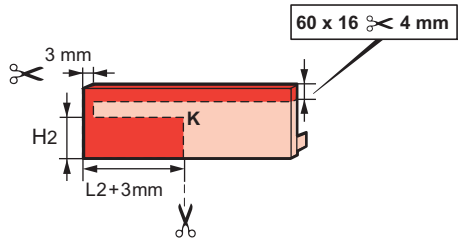

5

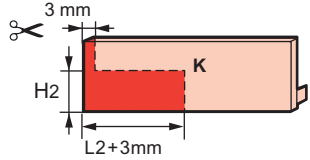
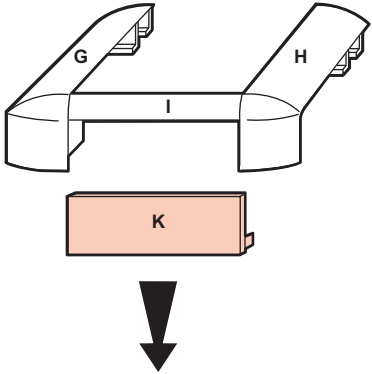
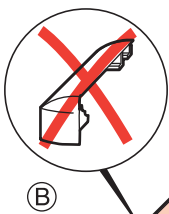

(B)

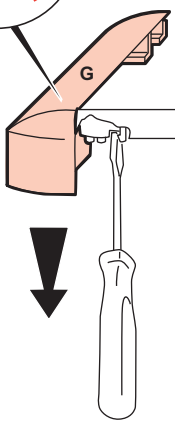

L1 = 60
L1 = 32

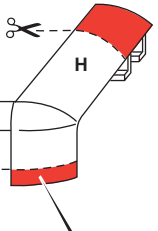
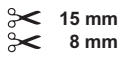

60 x 16 x 4 mm

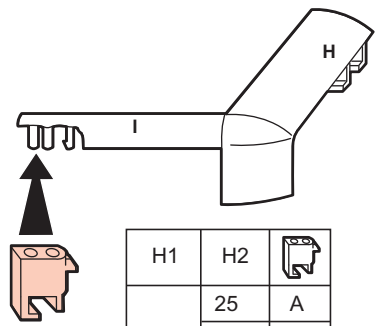

H1	H2	
25	25	A
	20	C
	16	E
20	12,5	F
	20	A
	16	B
16	12,5	D
	16	A
12,5	12,5	B
	12,5	A

6

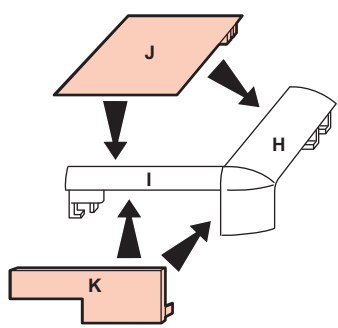

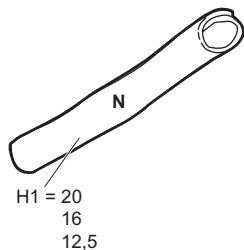
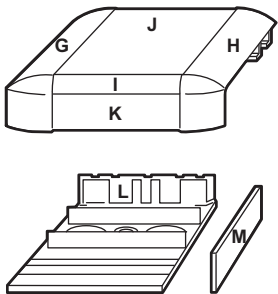
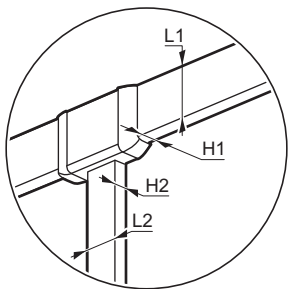

1

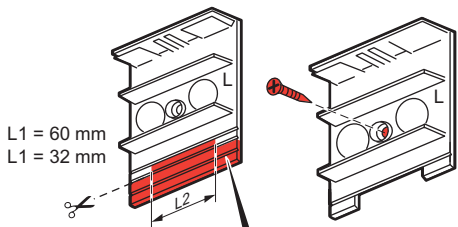
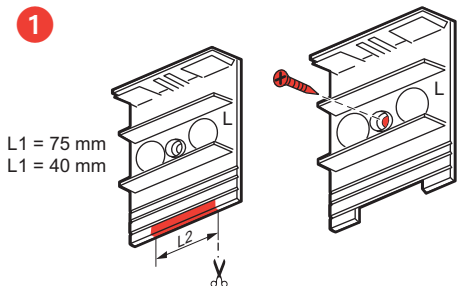

L1 = 60 mm \times 15 mm

L1 = 32 mm \times 8 mm

2

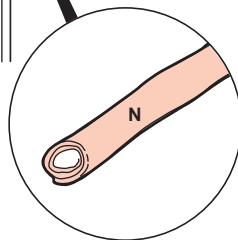
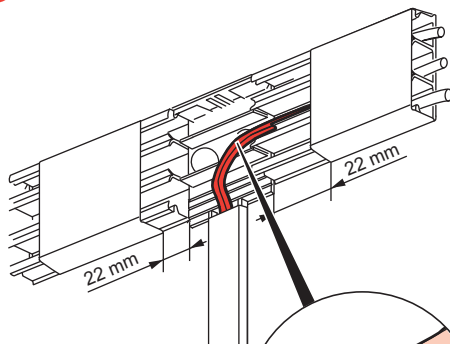

3

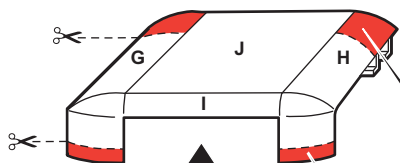

L1 = 60 mm \times 15 mm

L1 = 32 mm \times 8 mm

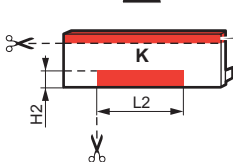

60 x 16 \times 4 mm

